

Article number: 439700540

Description: Rota-fix shaft-hub connection FL540x675

Note: Self centering - very high torque

## Measures

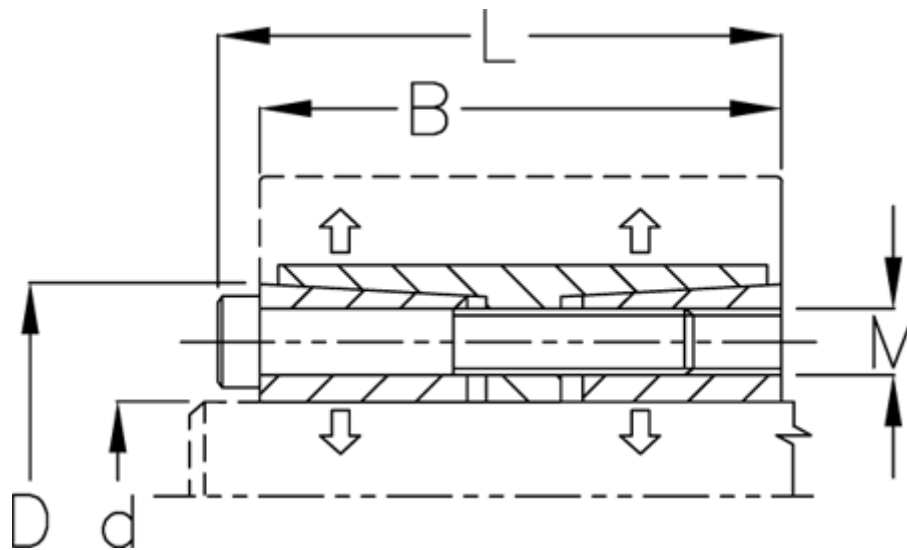

B mm	= 280
d H8 mm	= 540
D mm	= 675
Fit tolerance	= Aksel h8, Nav H8
F kN torque	= 8111.0
L mm	= 307
M mm	= M27
P N/mm <sup>2</sup> surface pressure on shaft/hub	= 135

Surface roughness	= R? ? 3.2 $\mu$ m
T N m torque	= 999999
Ts N m bolt tightening torque	= 1750.0